

Clad Eagle Axiom™ Casements

Elevations 1' - 5 3/4" Units

Scale: 1/4" = 1' 0"

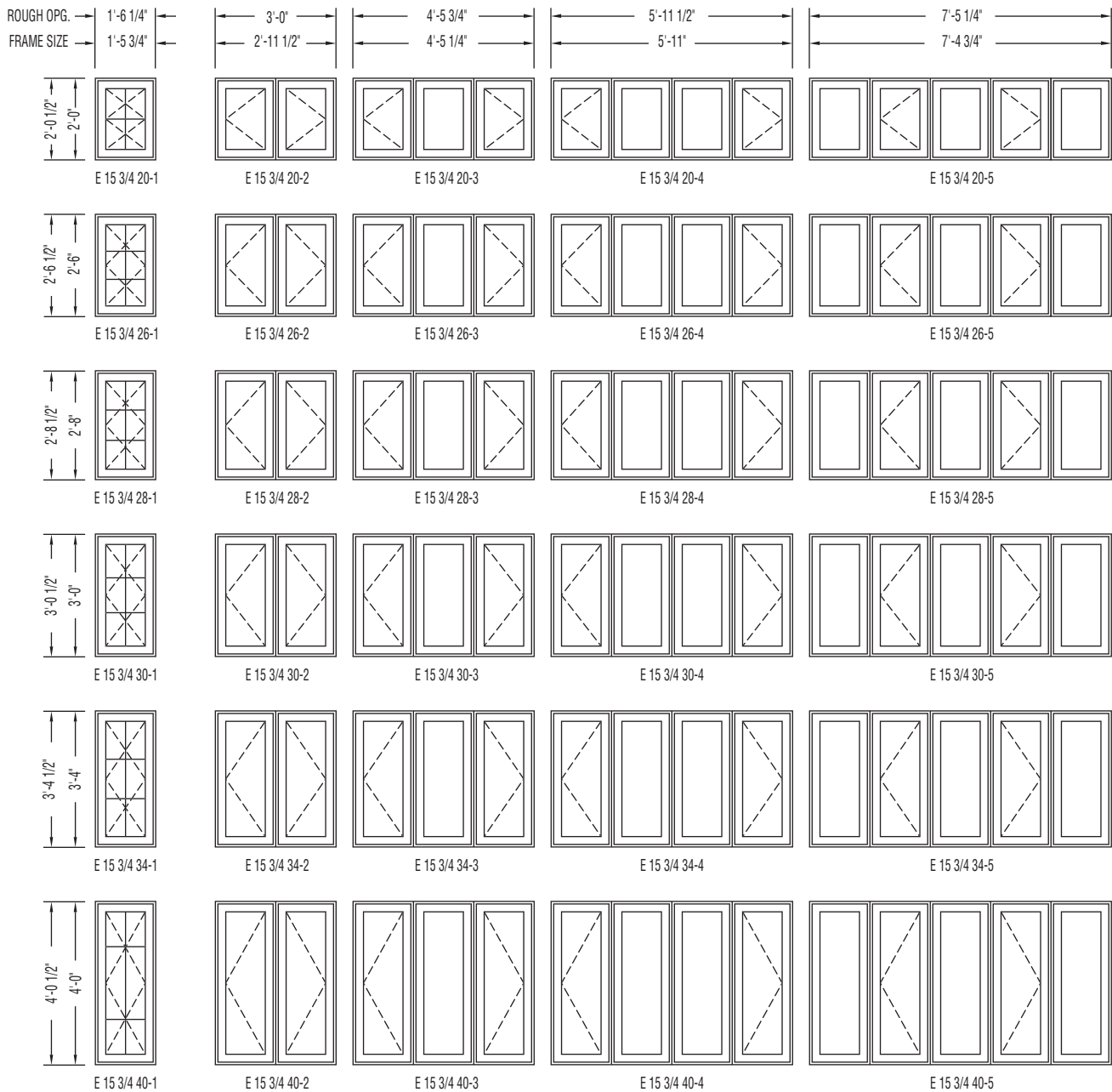

NOTE: Additional custom sizes are available. Please contact your EAGLE Representative for more information.

Use structural mullion reinforcements when necessary or required by code.

For a metric equivalent in millimeters, multiply dimensions in inches by 25.4.

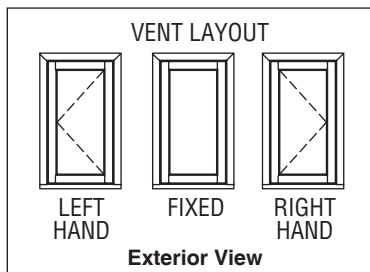

“Traditional Style” Modern Divided Lights®, Classic Divided Lights, between-the-glass muntins and standard removable rectangular wood grille patterns are illustrated in the single elevation drawings. Please contact your EAGLE Representative for custom pattern information.

Clad Eagle Axiom™ Casements

Elevations 1' - 5 3/4" Units

Scale: 1/4" = 1' 0"

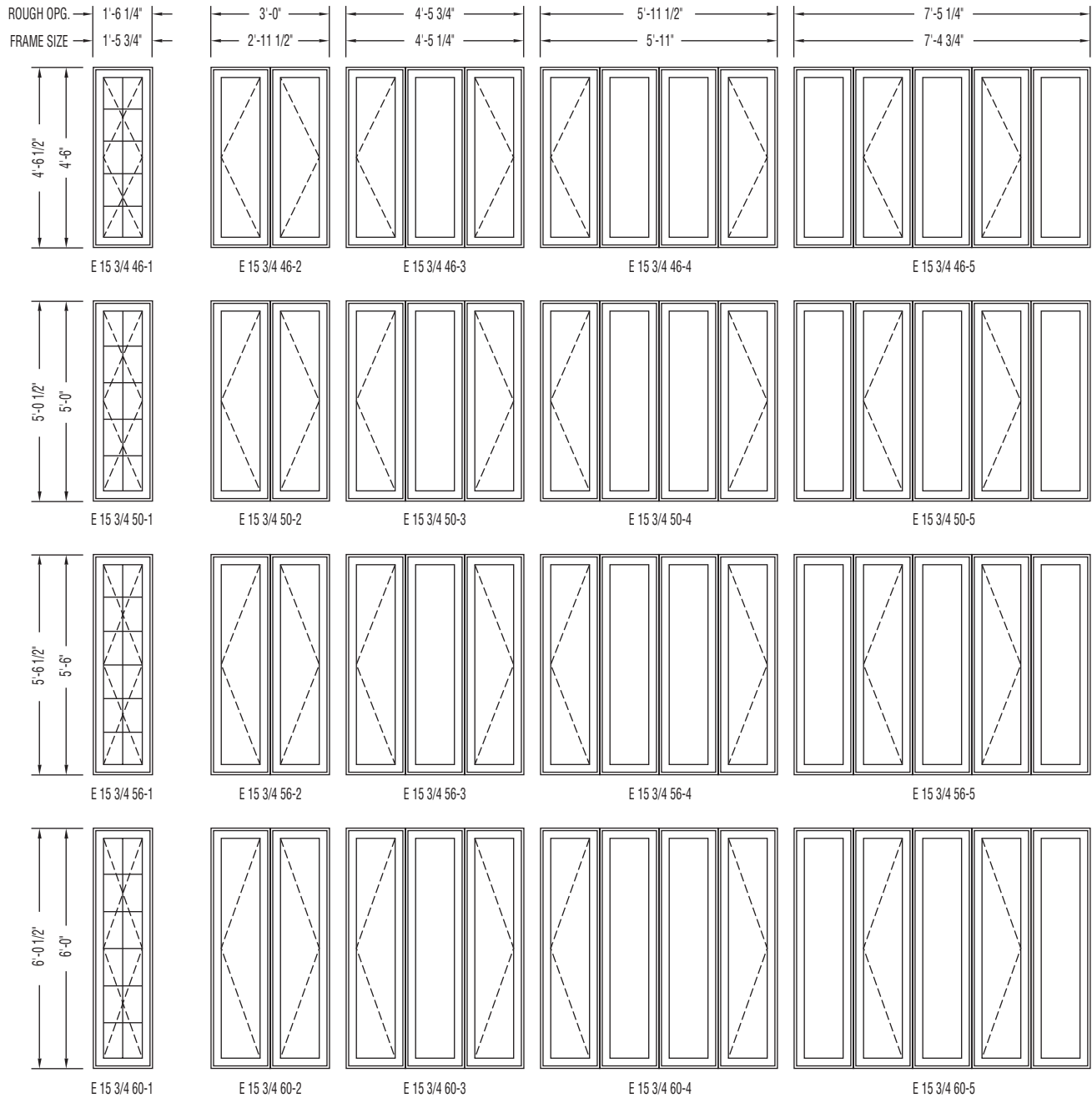

Clad Eagle Axiom™ Casements

Elevations 1' - 8" Units

Scale: 1/4" = 1' 0"

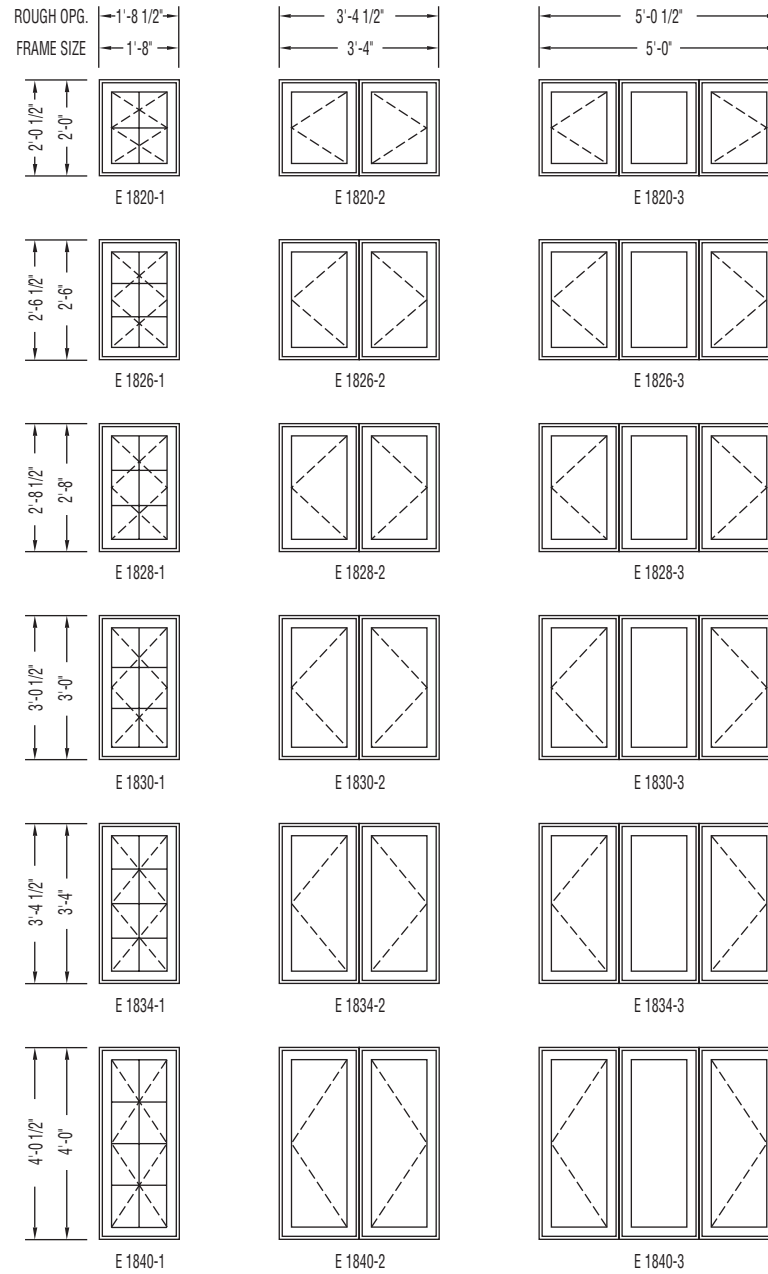

Clad Eagle Axiom™ Casements

Elevations 1' - 8" Units

Scale: 1/4" = 1' 0"

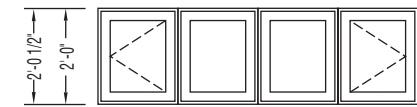
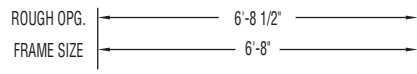

E 1820-4

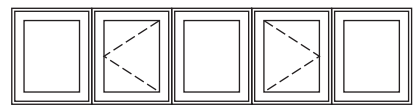
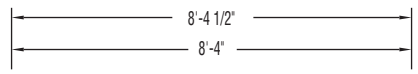

E 1820-5

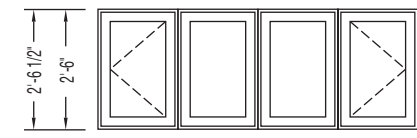

E 1826-4

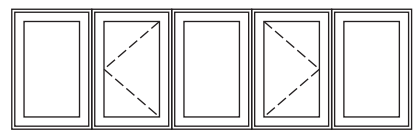

E 1826-5

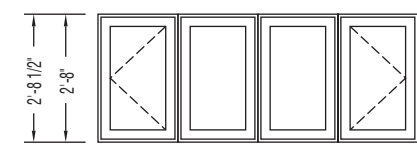

E 1828-4

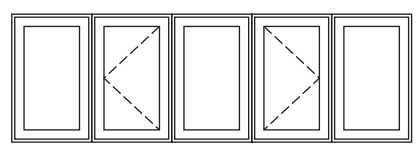

E 1828-5

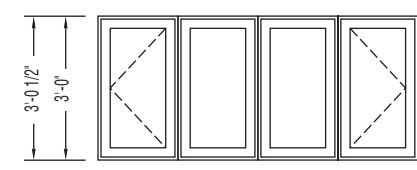

E 1830-4

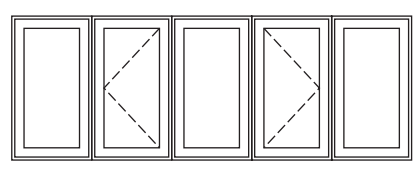

E 1830-5

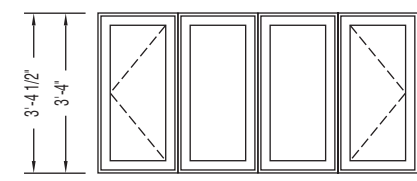

E 1834-4

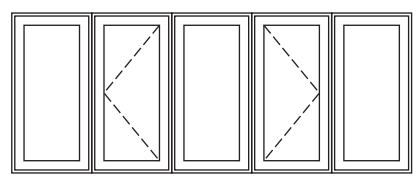

E 1834-5

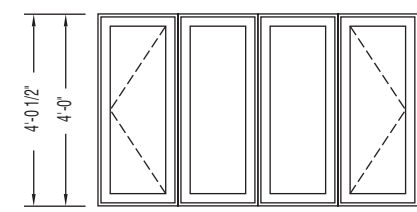

E 1840-4

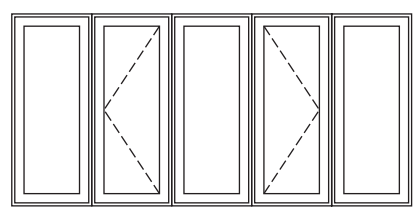

E 1840-5

Clad Eagle Axiom™ Casements

Elevations 1' - 8" Units

Scale: 1/4" = 1' 0"

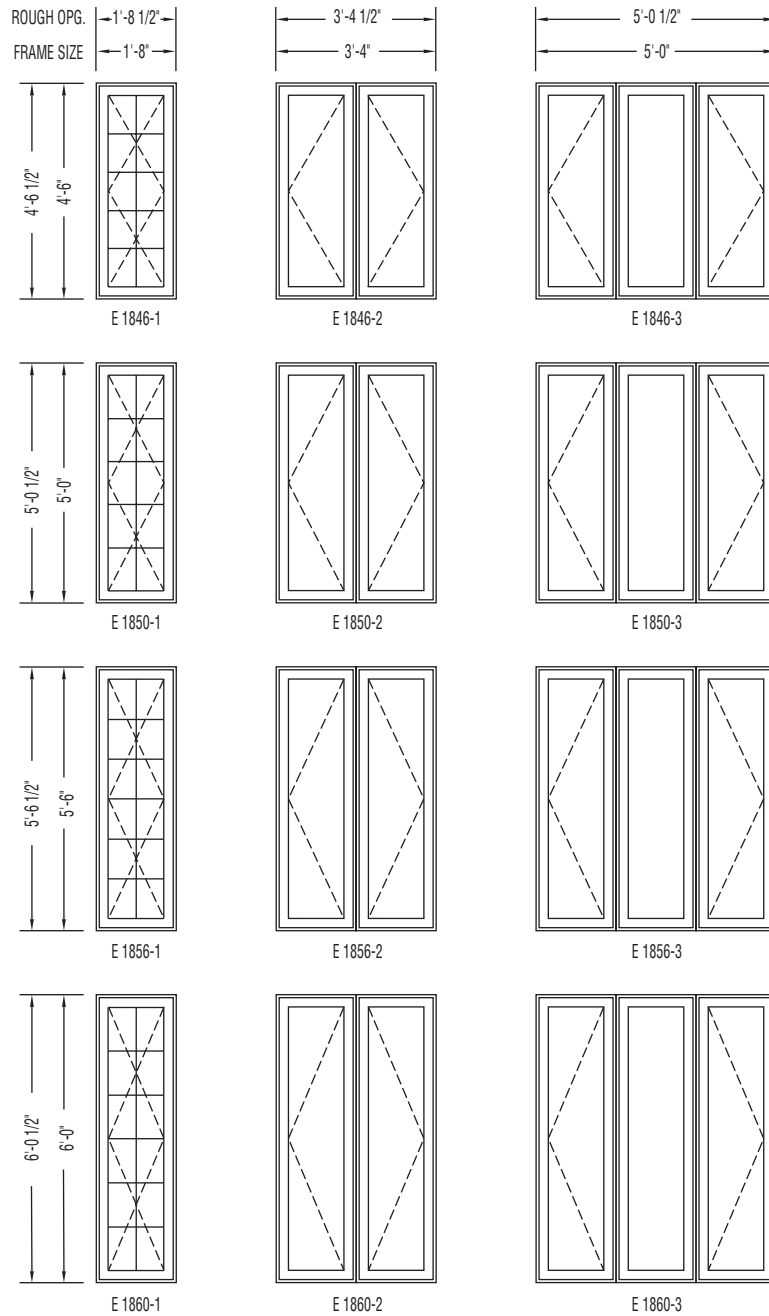

Clad Eagle Axiom™ Casements

Elevations 1' - 8" Units

Scale: 1/4" = 1' 0"

ROUGH OPG. 6'-8 1/2"
FRAME SIZE 6'-8"

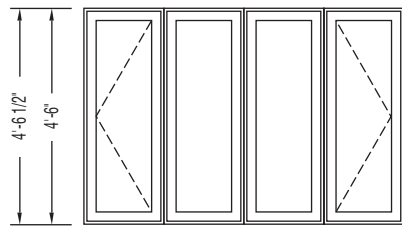

E 1846-4

8'-4 1/2"
8'-4"

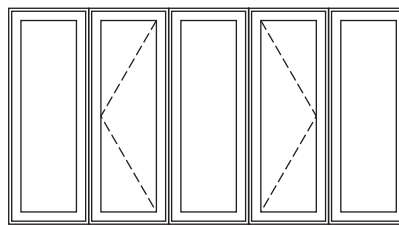

E 1846-5

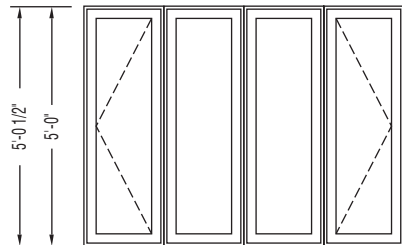

E 1850-4

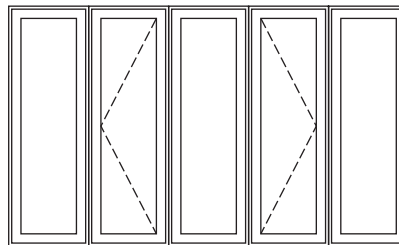

E 1850-5

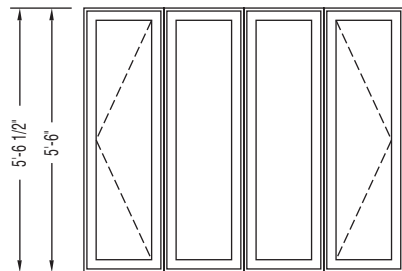

E 1856-4

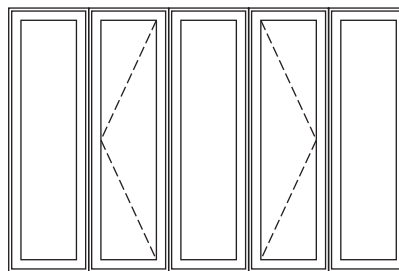

E 1856-5

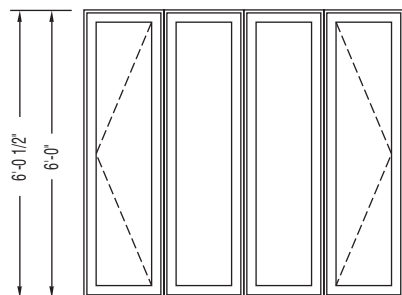

E 1860-4

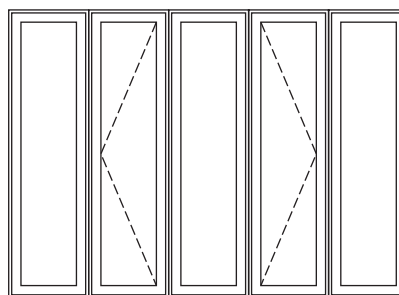

E 1860-5

Clad Eagle Axiom™ Casements

Elevations 2' - 0" Units

Scale: 1/4" = 1' 0"

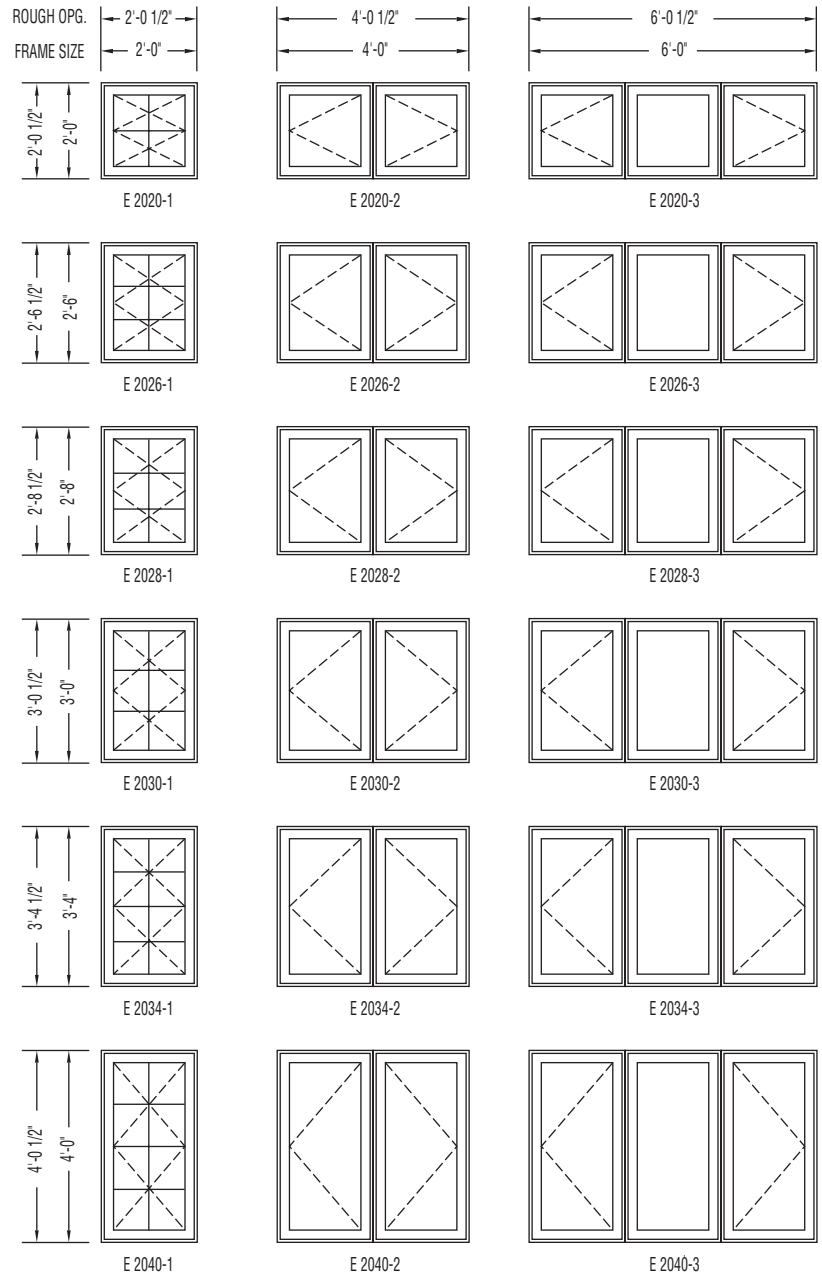

Clad Eagle Axiom™ Casements

Elevations 2' - 0" Units

Scale: 1/4" = 1' 0"

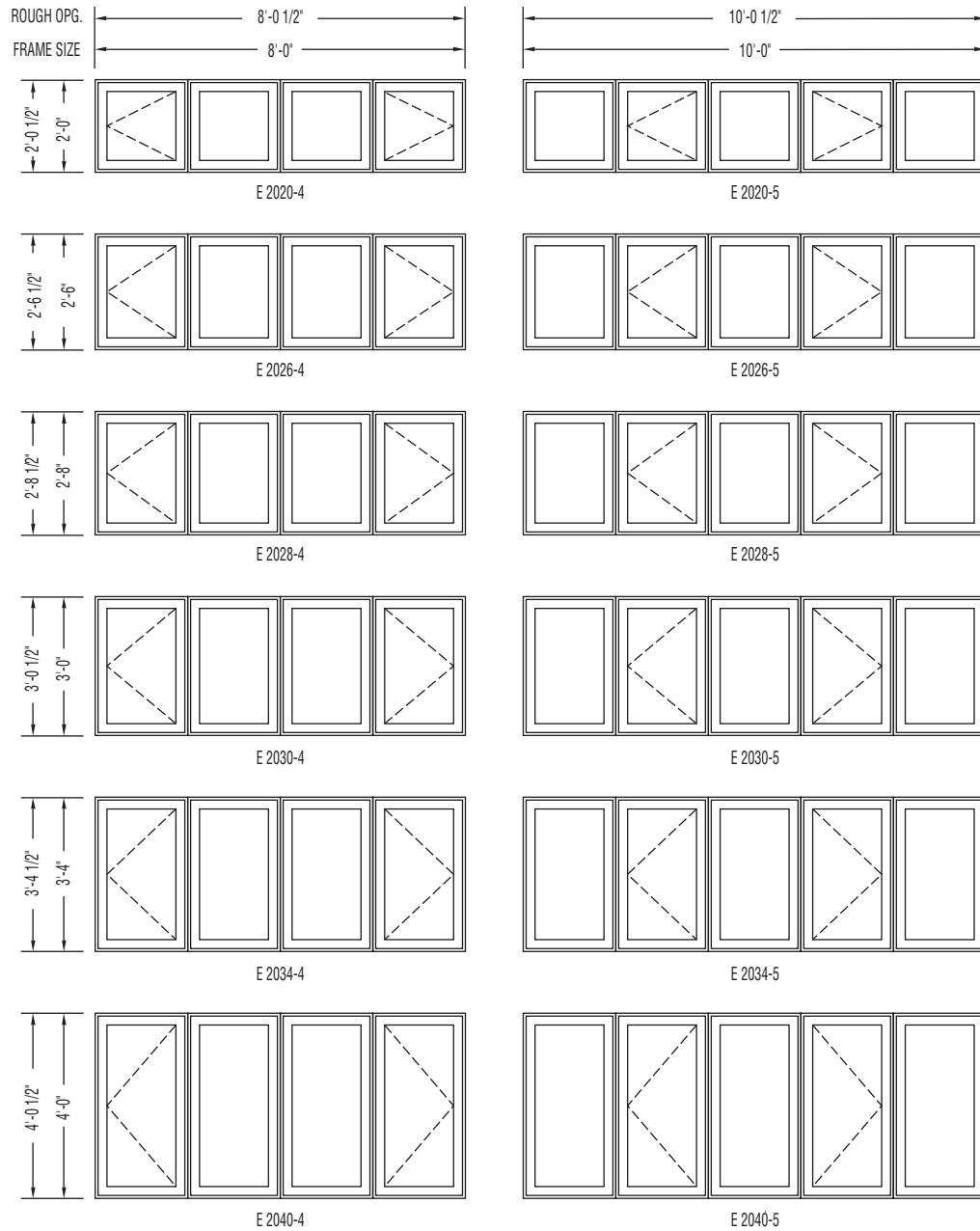

Clad Eagle Axiom™ Casements

Elevations 2' - 0" Units

Scale: 1/4" = 1' 0"

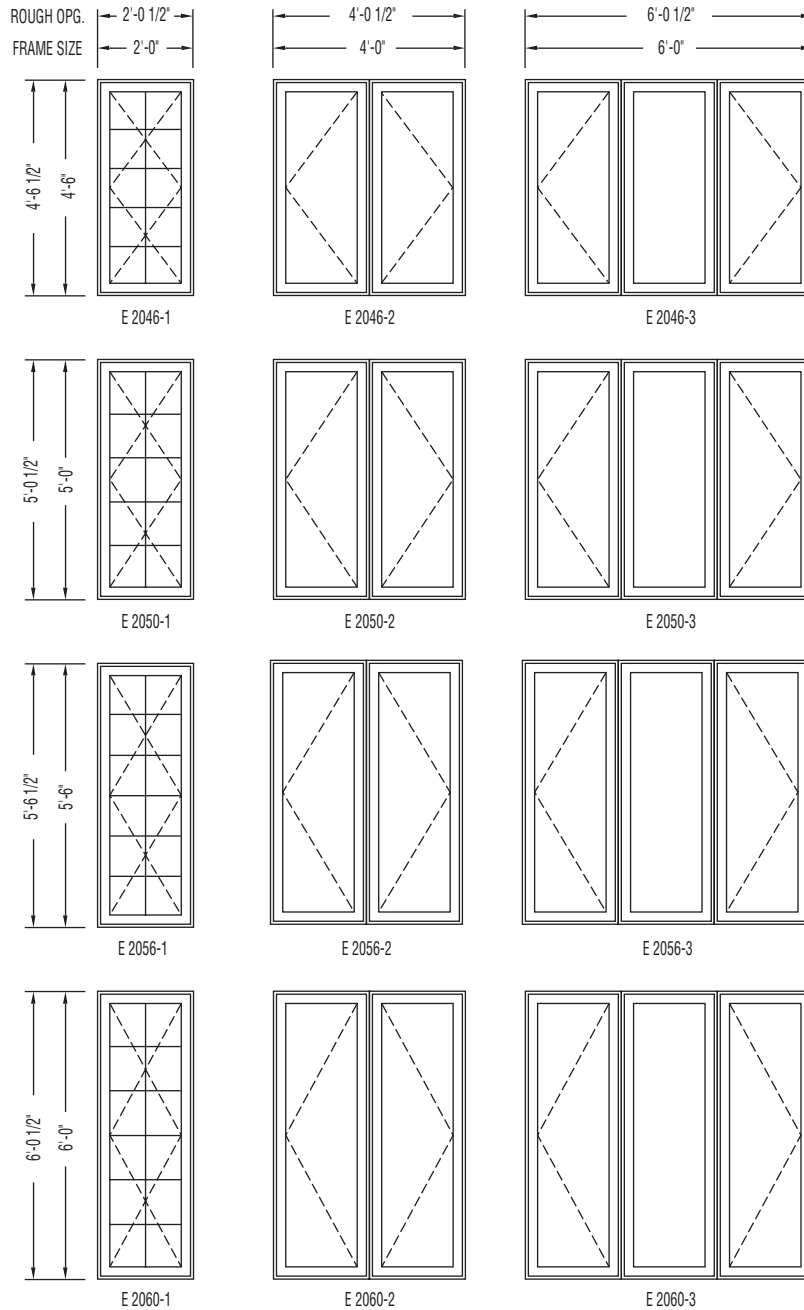

Clad Eagle Axiom™ Casements

Elevations 2' - 0" Units

Scale: 1/4" = 1' 0"

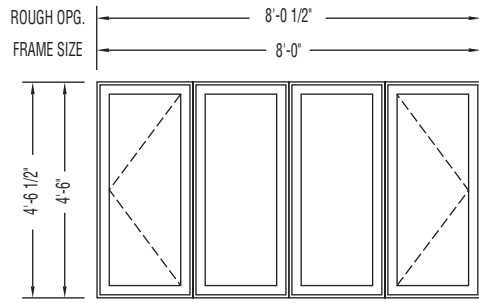

E 2046-4

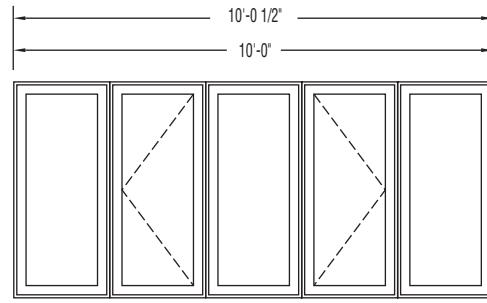

E 2046-5

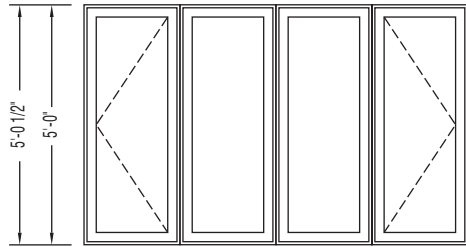

E 2050-4

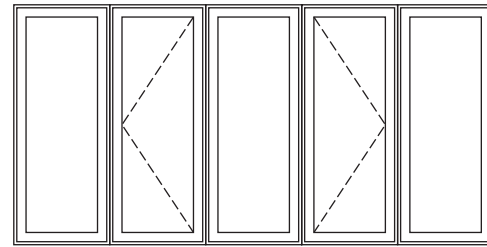

E 2050-5

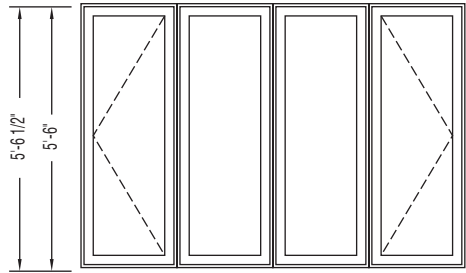

E 2056-4

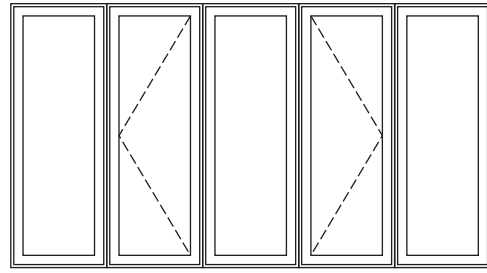

E 2056-5

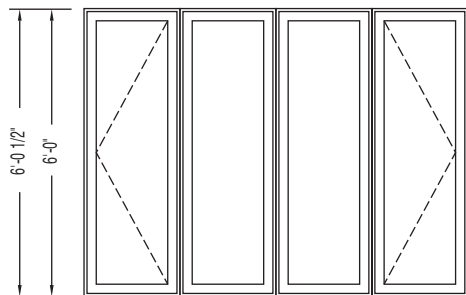

E 2060-4

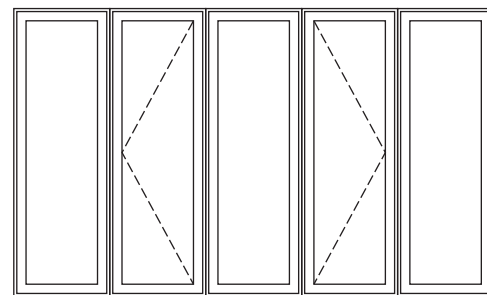

E 2060-5

Clad Eagle Axiom™ Casements

Elevations 2' - 4" Units

Scale: 1/4" = 1' 0"

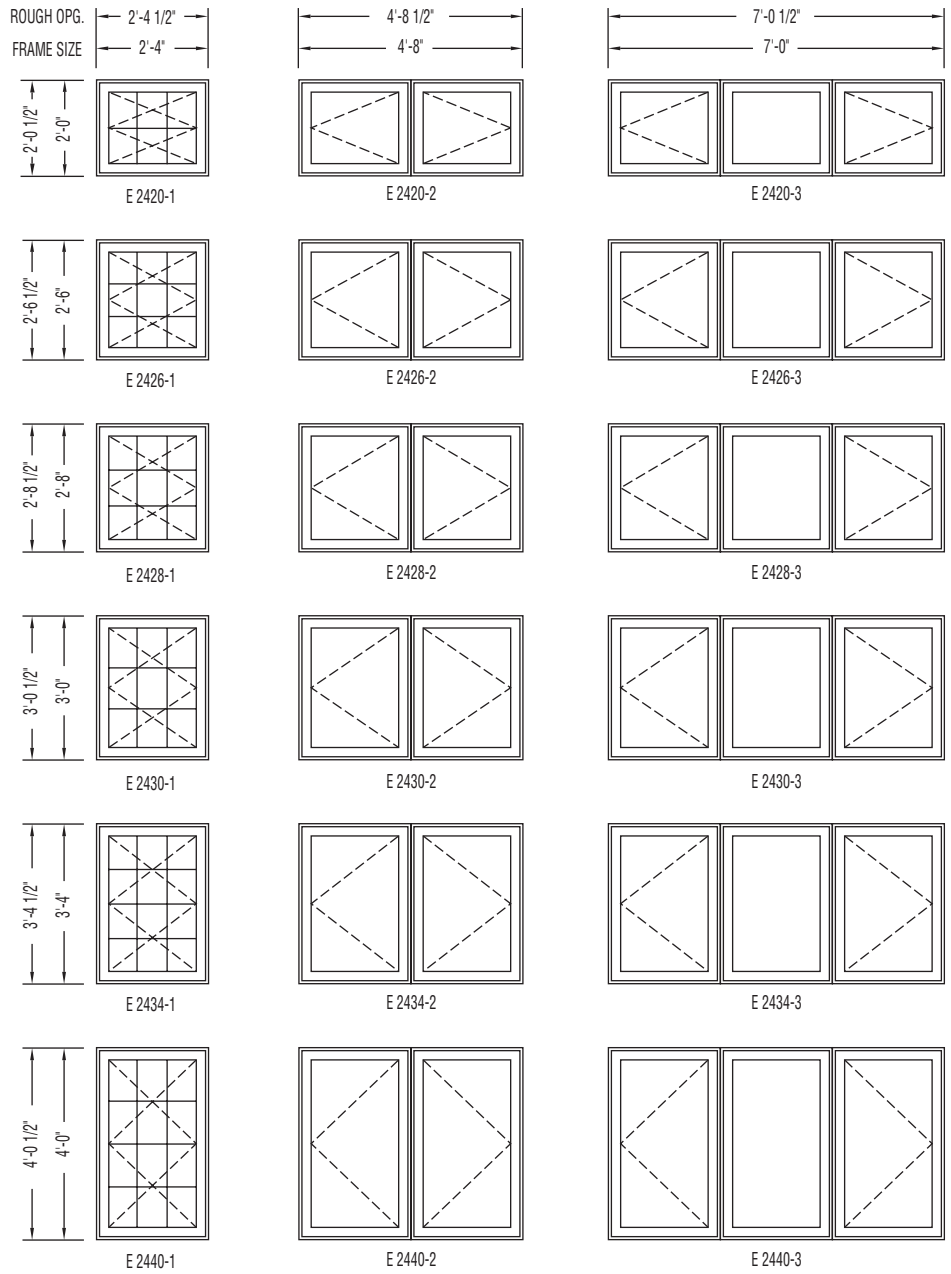

Clad Eagle Axiom™ Casements

Elevations 2' - 4" Units

Scale: 1/4" = 1' 0"

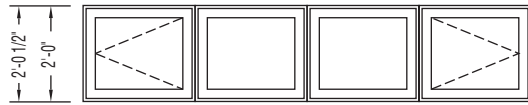
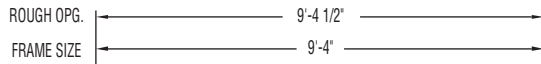

E 2420-4

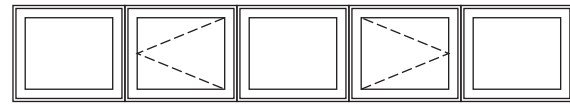
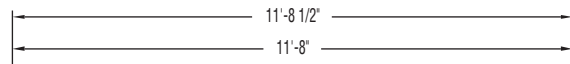

E 2420-5

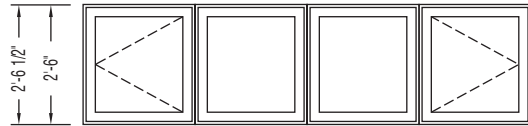

E 2426-4

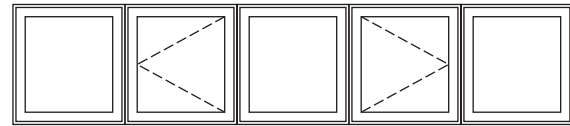

E 2426-5

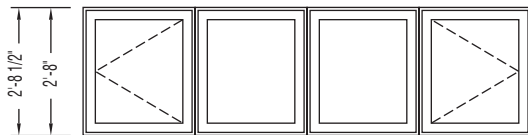

E 2428-4

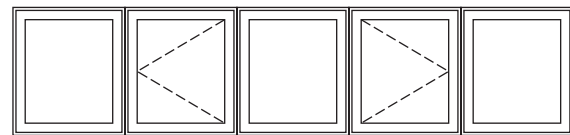

E 2428-5

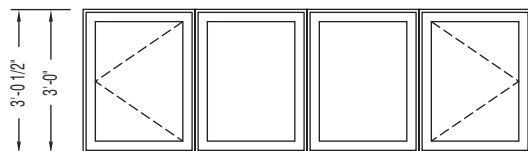

E 2430-4

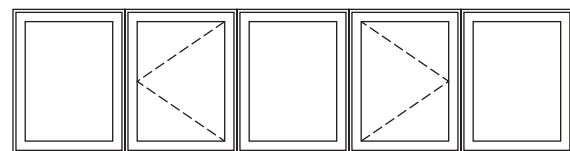

E 2430-5

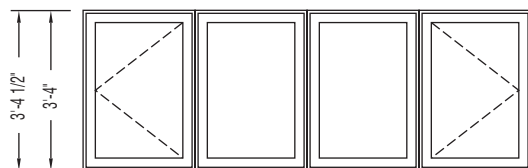

E 2434-4

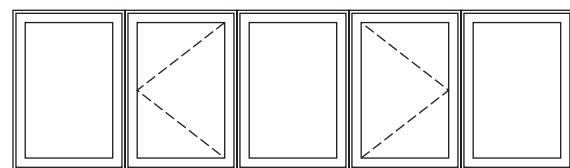

E 2434-5

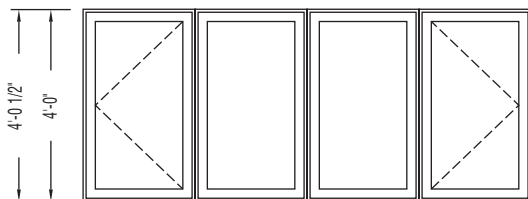

E 2440-4

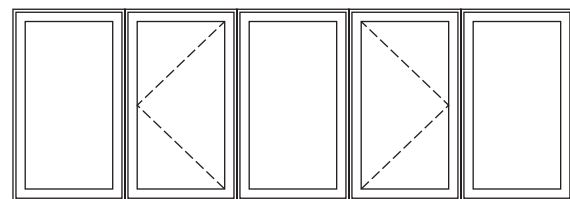

E 2440-5

Clad Eagle Axiom™ Casements

Elevations 2' - 4" Units

Scale: 1/4" = 1' 0"

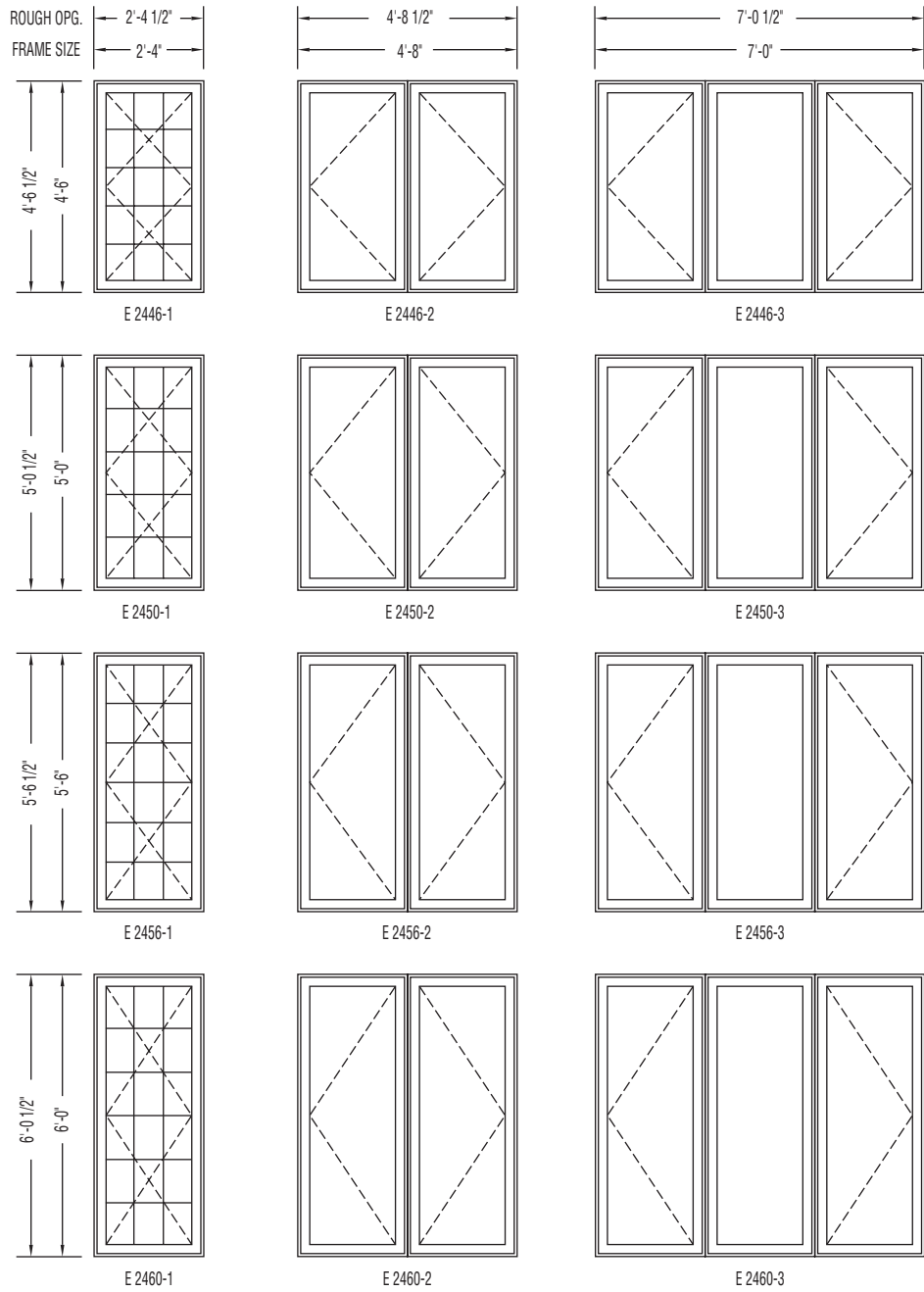

Clad Eagle Axiom™ Casements

Elevations 2' - 4" Units

Scale: 1/4" = 1' 0"

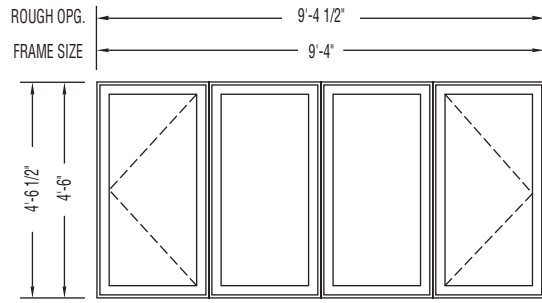

E 2446-4

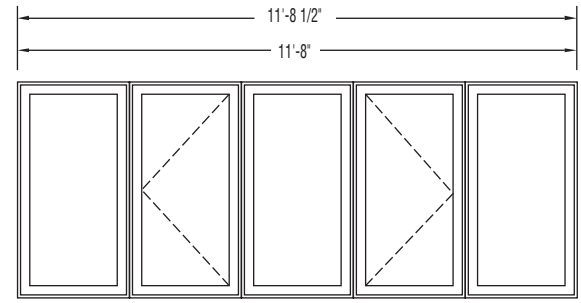

E 2446-5

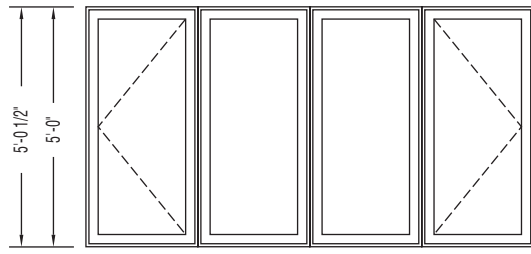

E 2450-4

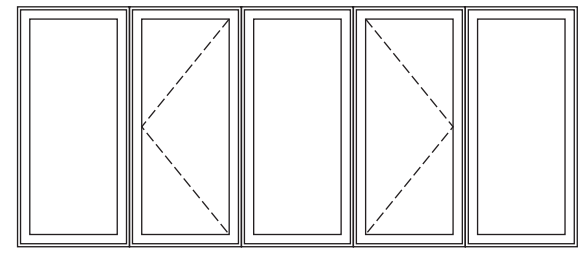

E 2450-5

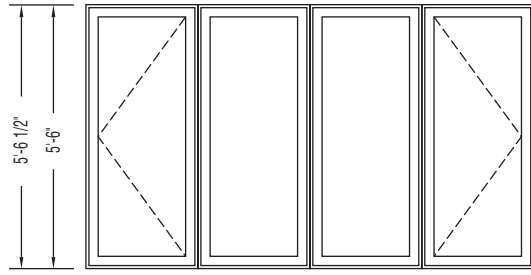

E 2456-4

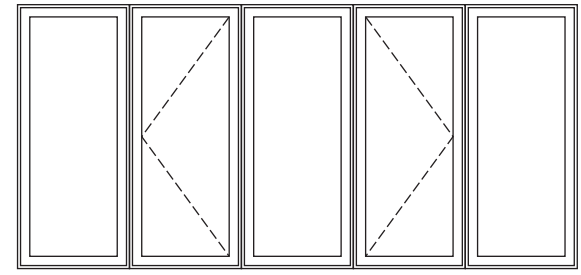

E 2456-5

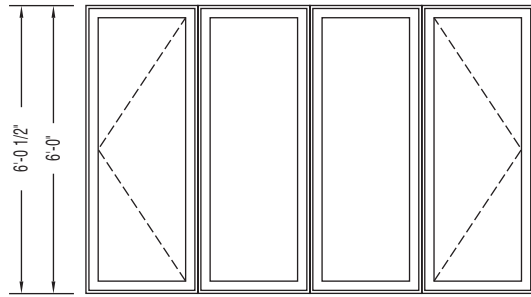

E 2460-4

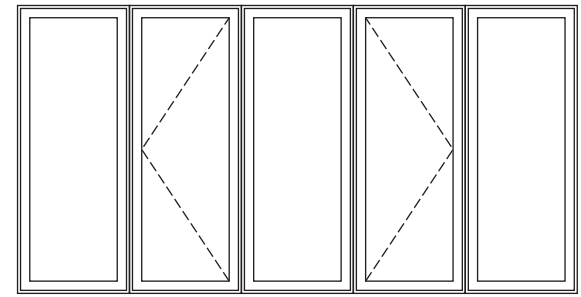

E 2460-5

Clad Eagle Axiom™ Casements

Elevations 2' - 6" Units

Scale: 1/4" = 1' 0"

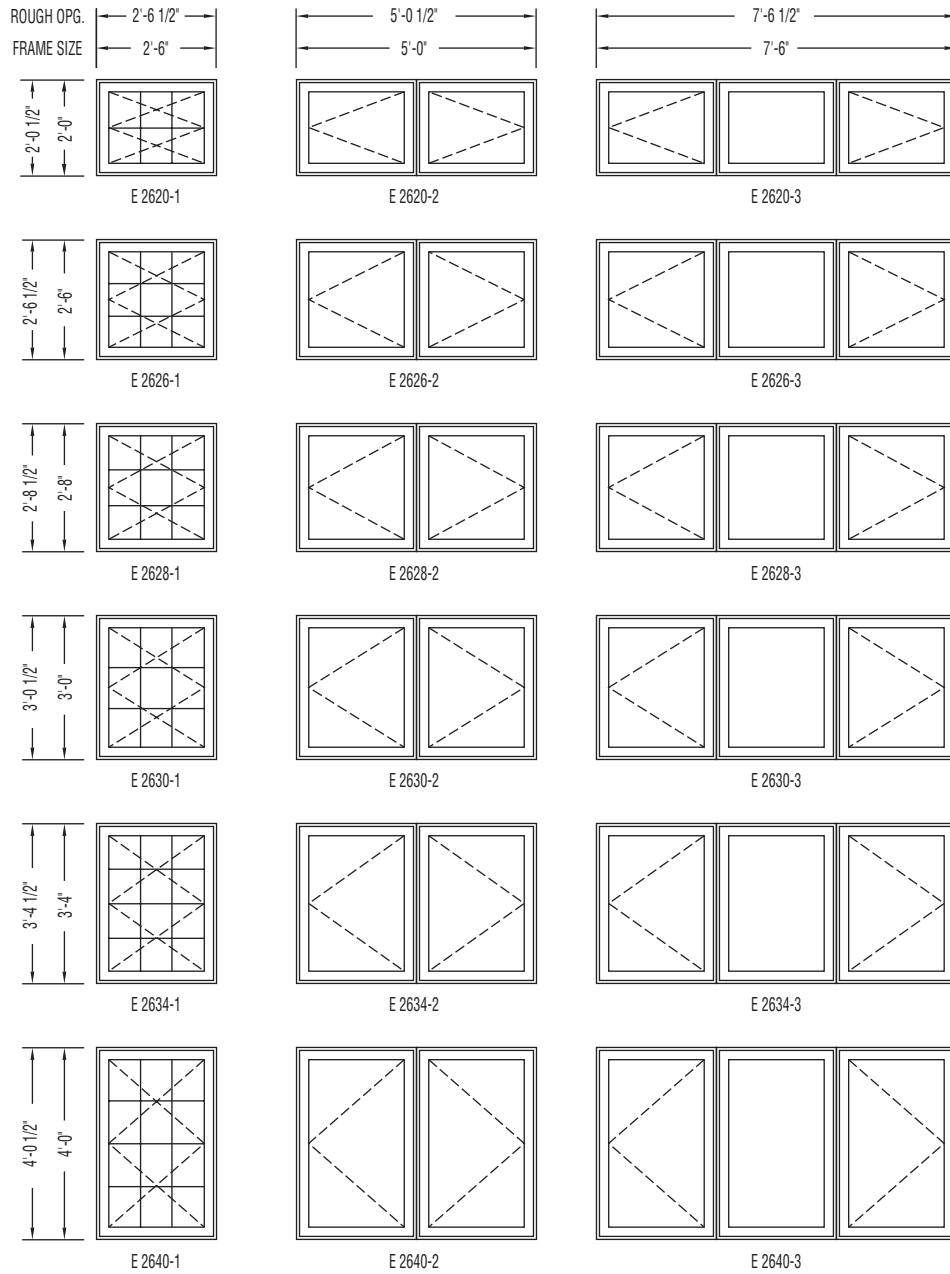

Clad Eagle Axiom™ Casements

Elevations 2' - 6" Units

Scale: 1/4" = 1' 0"

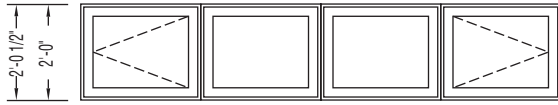
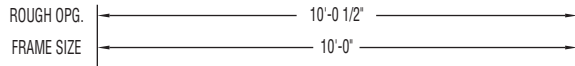

E 2620-4

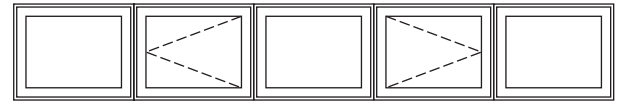
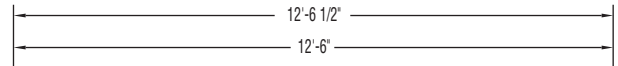

E 2620-5

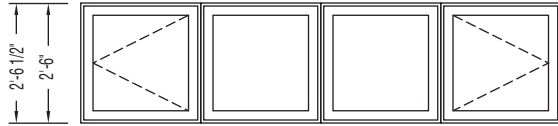

E 2626-4

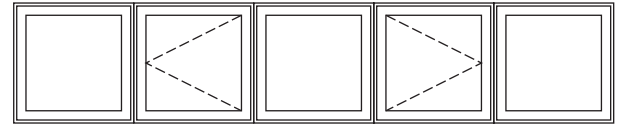

E 2626-5

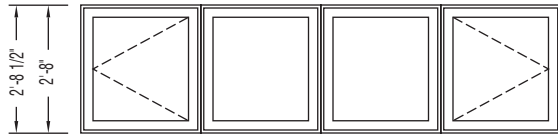

E 2628-4

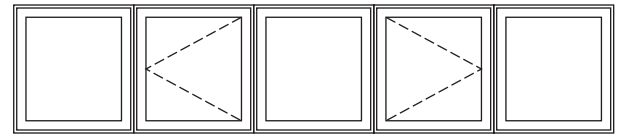

E 2628-5

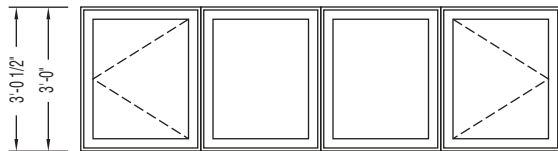

E 2630-4

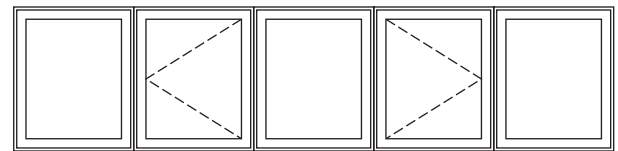

E 2630-5

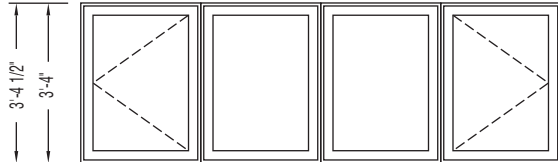

E 2634-4

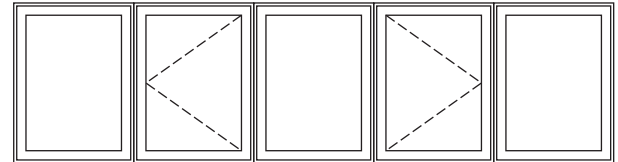

E 2634-5

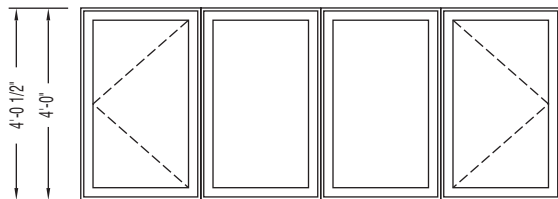

E 2640-4

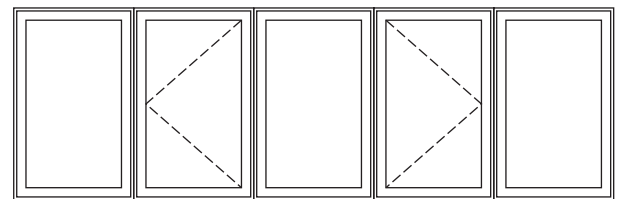

E 2640-5

Clad Eagle Axiom™ Casements

Elevations 2' - 6" Units

Scale: 1/4" = 1' 0"

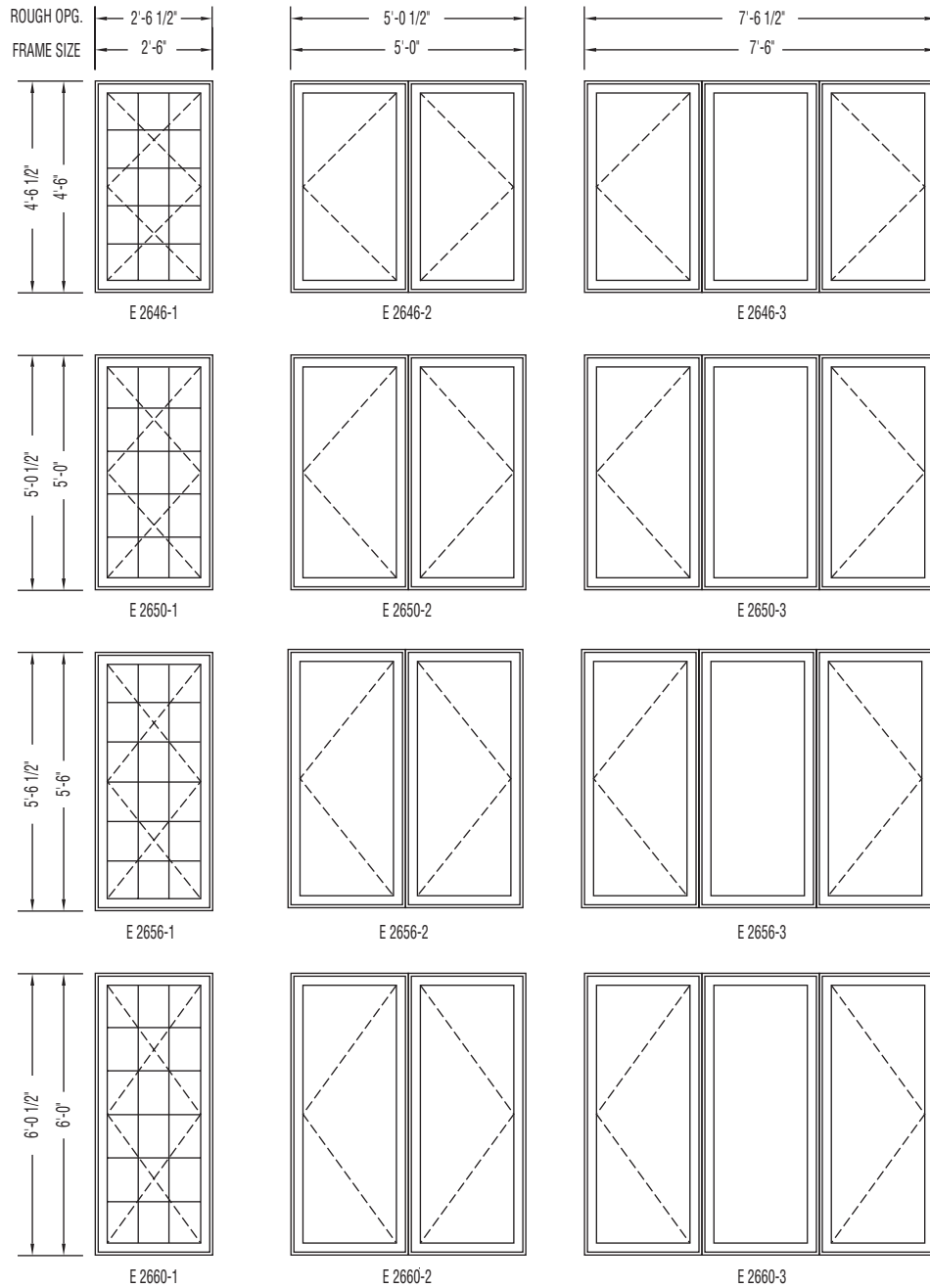

Clad Eagle Axiom™ Casements

Elevations 2' - 6" Units

Scale: 1/4" = 1' 0"

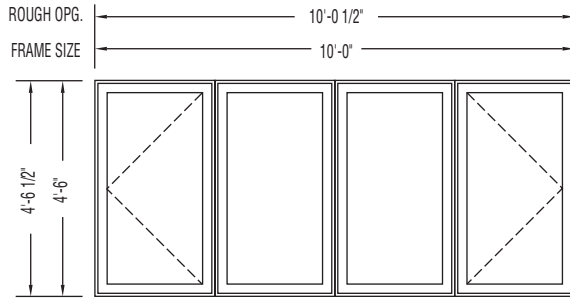

E 2646-4

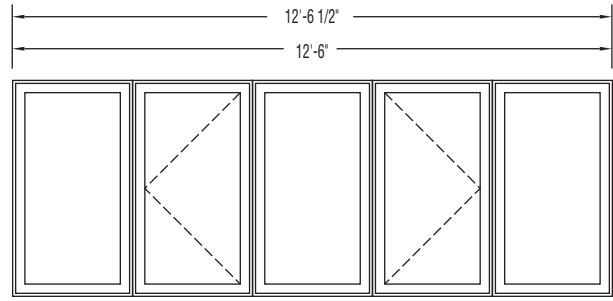

E 2646-5

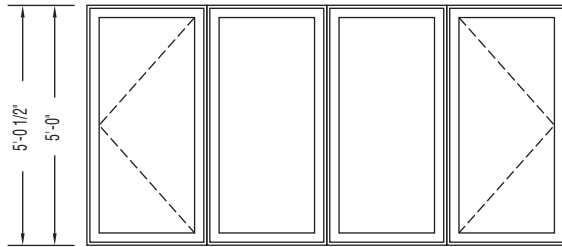

E 2650-4

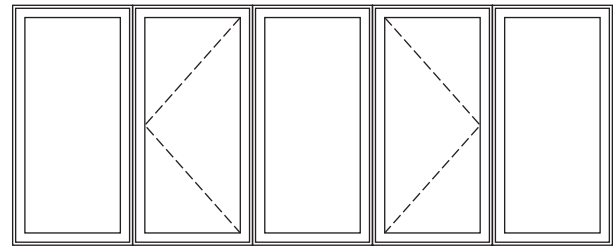

E 2650-5

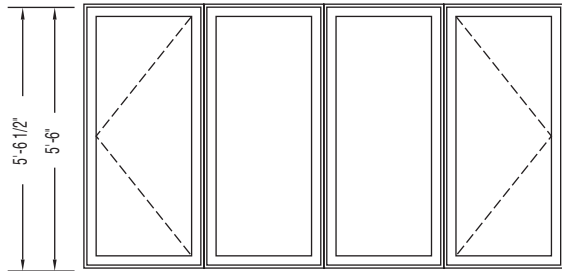

E 2656-4

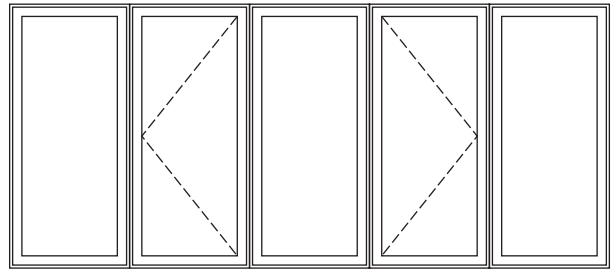

E 2656-5

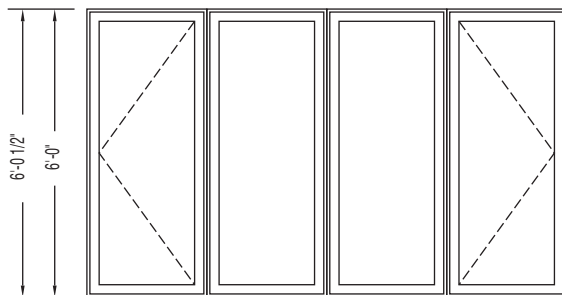

E 2660-4

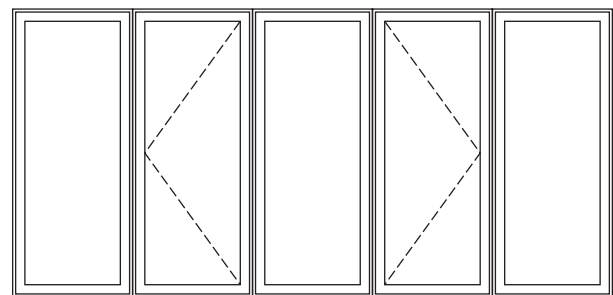

E 2660-5

Clad Eagle Axiom™ Casements

Elevations 2' - 8" Units

Scale: 1/4" = 1' 0"

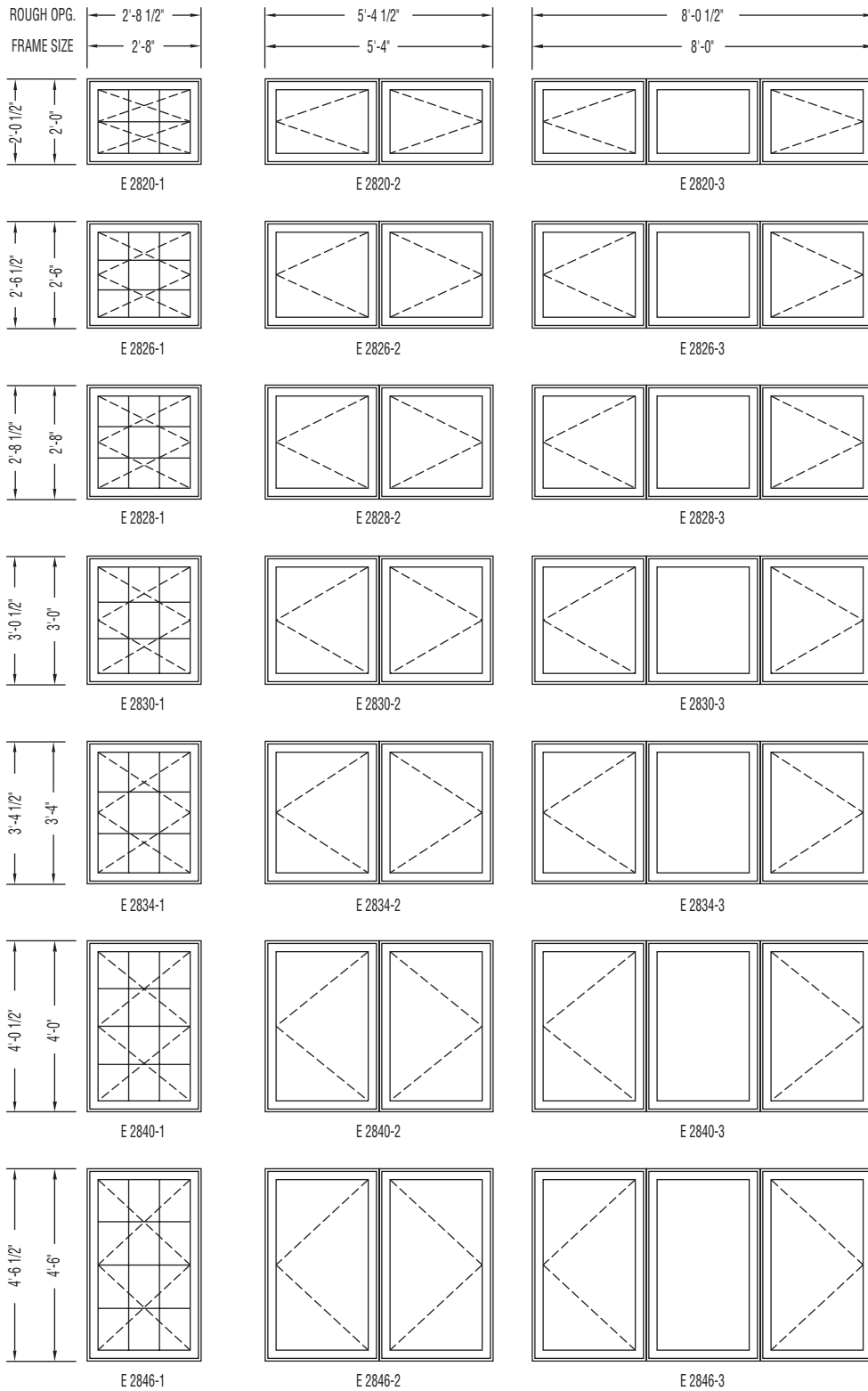

Clad Eagle Axiom™ Casements

Elevations 2' - 8" Units

Scale: 1/4" = 1' 0"

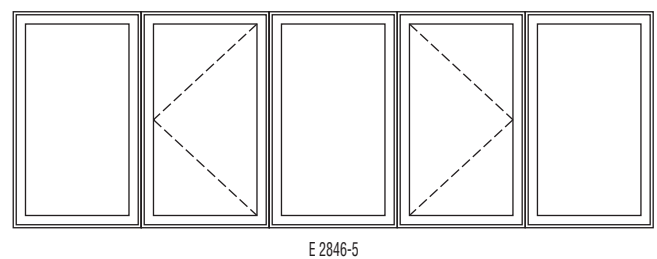
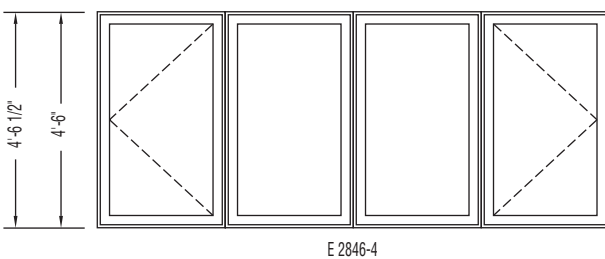
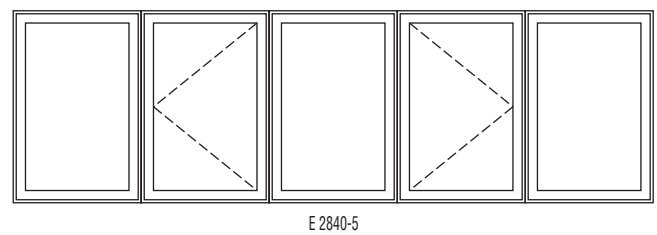
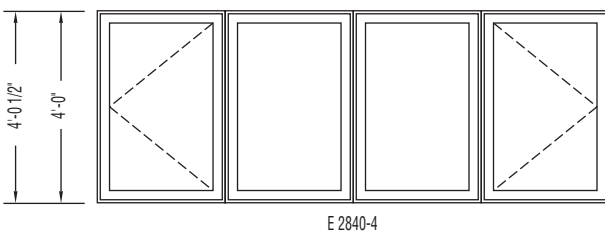
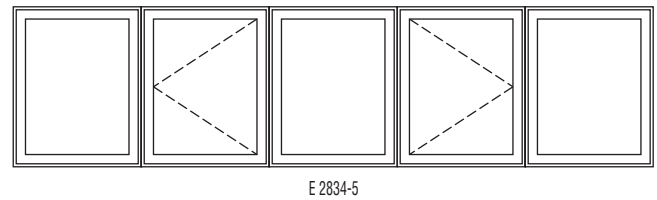
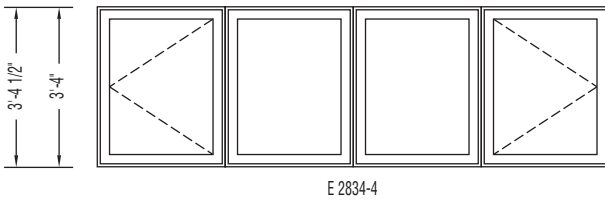
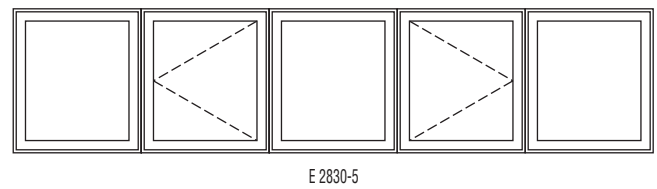
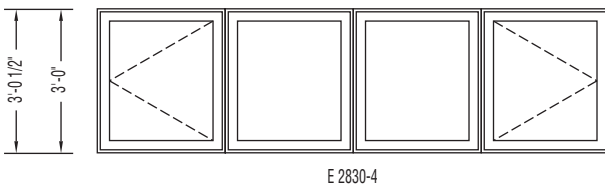
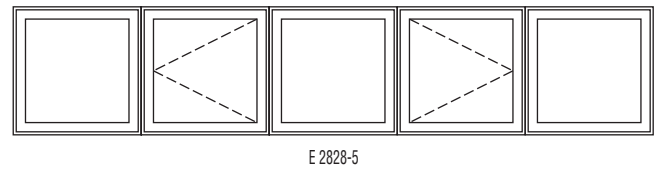
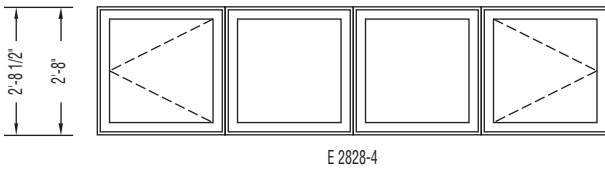
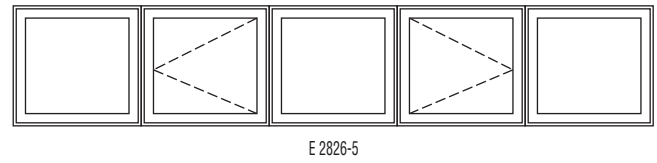
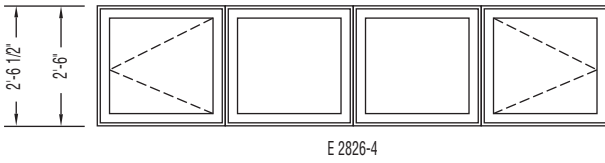
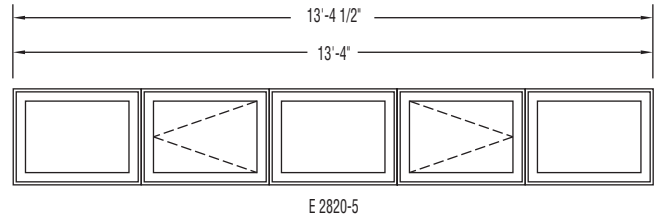
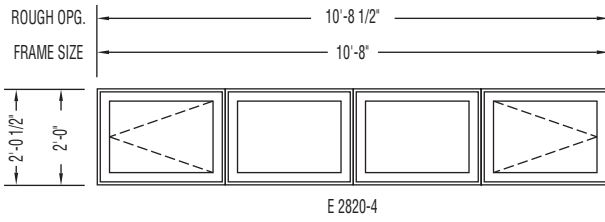

Clad Eagle Axiom™ Casements

Elevations 2' - 8" Units

Scale: 1/4" = 1' 0"

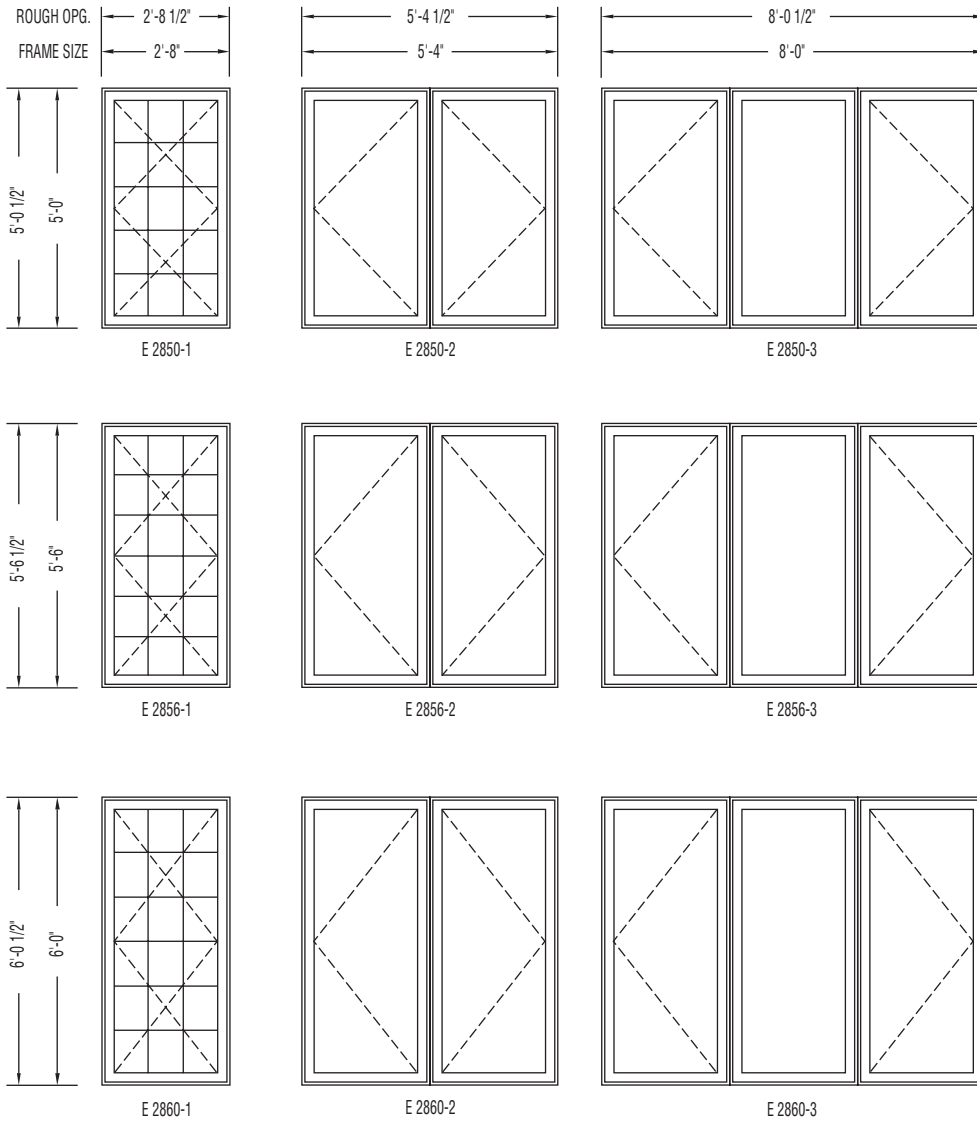

Clad Eagle Axiom™ Casements

Elevations 2' - 8" Units

Scale: 1/4" = 1' 0"

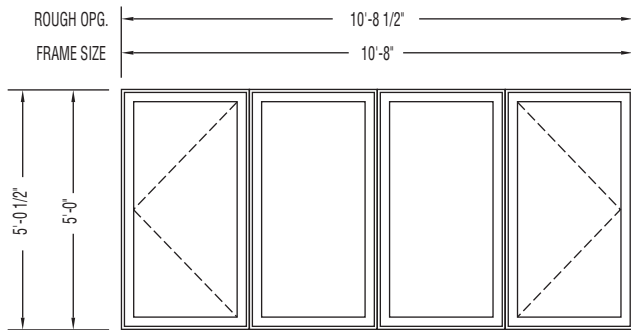

E 2850-4

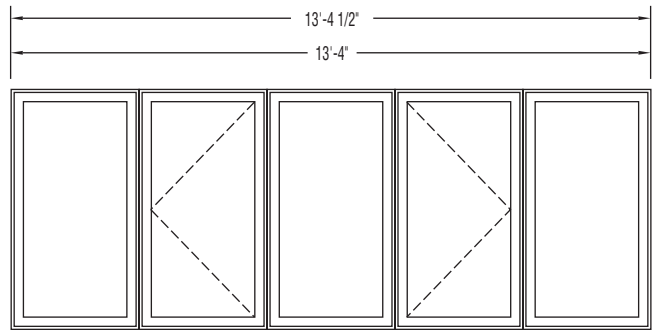

E 2850-5

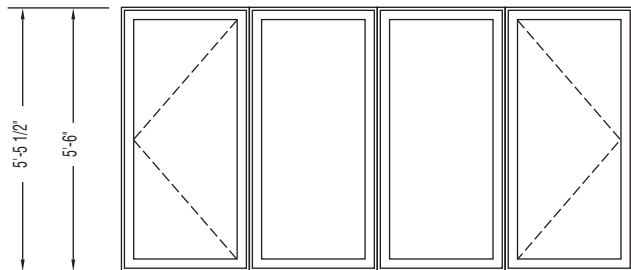

E 2856-4

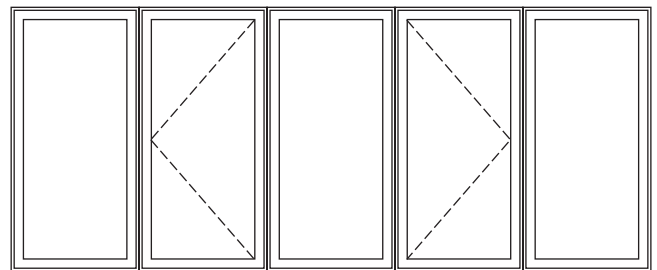

E 2856-5

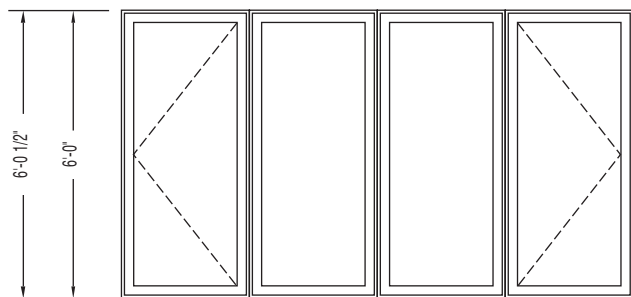

E 2860-4

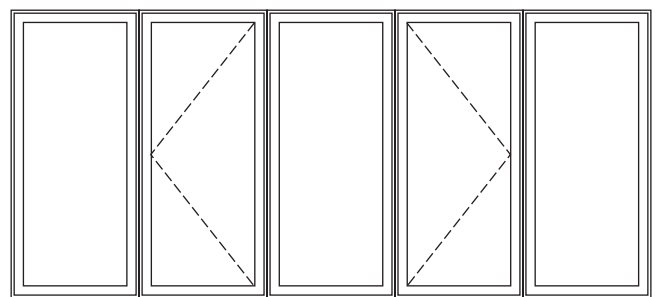

E 2860-5

Clad Eagle Axiom™ Casements

Elevations 3' - 0" Units

Scale: 1/4" = 1' 0"

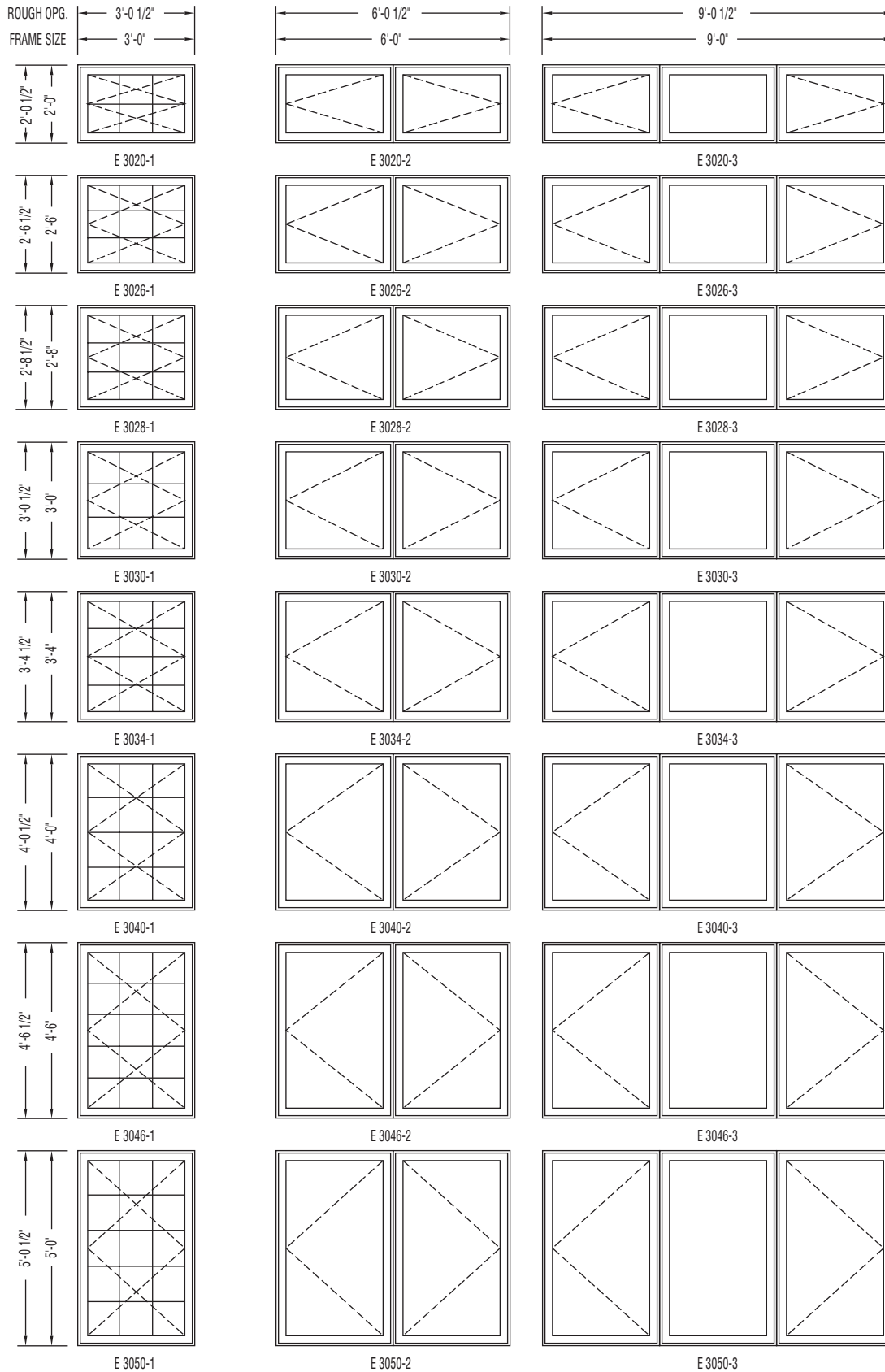

Clad Eagle Axiom™ Casements

Elevations 3' - 0" Units

Scale: 1/4" = 1' 0"

